

5100161-9 ✓ ACTIVE

Z-PACK | Z-PACK 2mm HM

TE Internal #: 5100161-9

Hard Metric Backplane Connectors, PCB Mount Receptacle, ≤ 1 Gb/s, 11 Column, 5 Row, Mezzanine, Board-to-Board, 55 Position, Z-PACK 2mm HM

[View on TE.com >](#)



[Connectors](#) > [PCB Connectors](#) > [Backplane Connectors](#) > [Hard Metric Connectors](#) >

HM Receptacle Connector: Traditional Backplane, Coplanar, 2mm

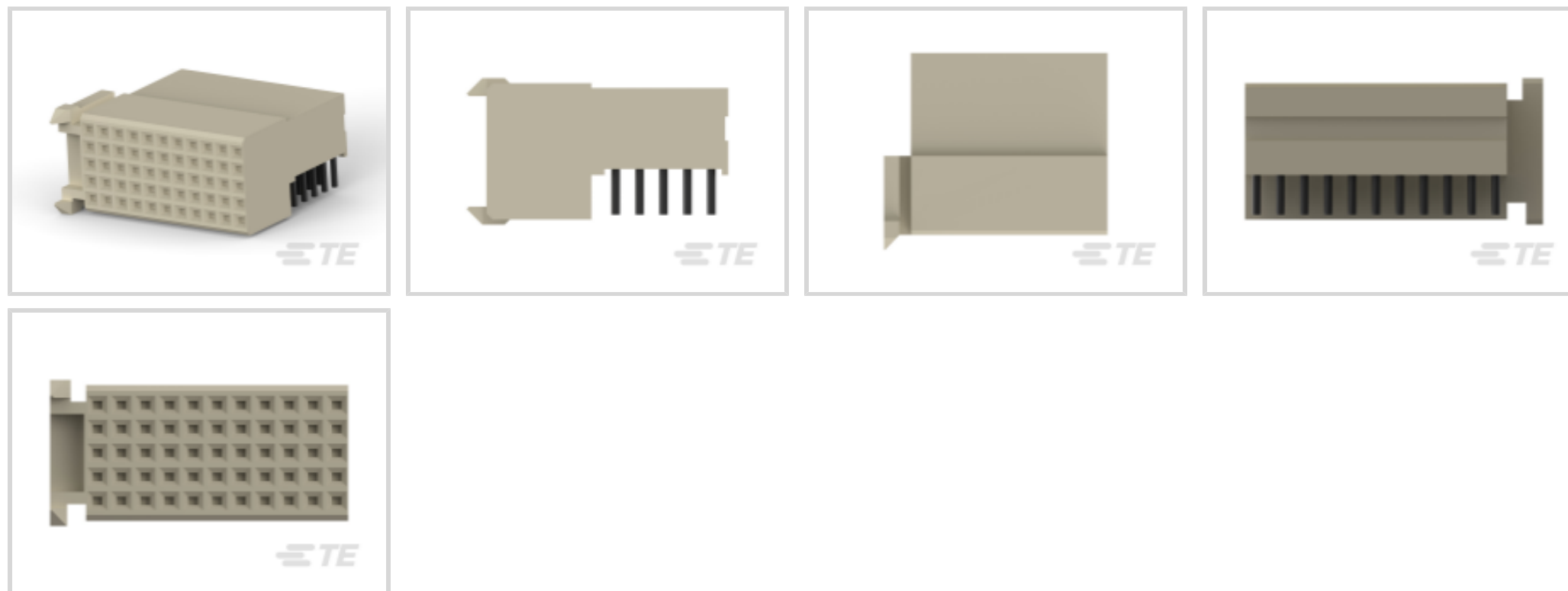

PCB Connector Assembly Type: **PCB Mount Receptacle**

Data Rate: ≤ 1 Gb/s

Number of Columns: 11

Number of Rows: 5

Backplane Architecture: **Mezzanine**

[All HM Receptacle Connector: Traditional Backplane, Coplanar, 2mm \(48\)](#)

Features

Product Type Features

Backplane Interface Type	2mm HM
PCB Connector Assembly Type	PCB Mount Receptacle
Connector System	Board-to-Board
Sealable	No
Connector & Contact Terminates To	Printed Circuit Board

Configuration Features

Rows Loaded	A, B, C, D, E
Number of Columns	11
Number of Rows	5
Backplane Architecture	Mezzanine
Number of Positions	55
PCB Mount Orientation	Right Angle



Signal Characteristics

Crosstalk Version	Standard
Data Rate	≤1 Gb/s

Contact Features

Feedthrough Post Length	3.7 mm
Contact Type	Socket
Contact Underplating Material	Nickel
PCB Contact Termination Area Plating Material	Tin
Contact Base Material	Phosphor Bronze
CompactPCI Designation	None
Contact Mating Area Plating Material	Gold, Gold Flash over Palladium Nickel
Contact Mating Area Plating Material Thickness	.76 μm[30 μin]
Contact Current Rating (Max)	1.5 A

Termination Features

Termination Method to Printed Circuit Board	Through Hole - Press-Fit
---	--------------------------

Mechanical Attachment

Mating Alignment Type	Guide Lugs
Connector Mounting Type	Board Mount

Housing Features

Housing Material	Polyester - GF
Centerline (Pitch)	2 mm[.078 in]
Housing Color	Gray

Dimensions

Backplane Module Length	25 mm
-------------------------	-------

Usage Conditions

Operating Temperature Range	-55 – 125 °C[-67 – 257 °F]
-----------------------------	----------------------------

Operation/Application

Shielded	No
Circuit Application	Power & Signal

Industry Standards

UL Flammability Rating	UL 94V-0
------------------------	----------



AdvancedTCA Specified Product

No

Packaging Features

Packaging Quantity

22

Packaging Method

Tube

Other

Comment

Connector lubricated with Bellcore approved lubricant., Connector tested and qualified against Bellcore Quality Level III, Central Office Applications.

Product Compliance

For compliance documentation, visit the product page on [TE.com](https://www.te.com)>

EU RoHS Directive 2011/65/EU

Compliant

EU ELV Directive 2000/53/EC

Compliant

China RoHS 2 Directive MIIT Order No 32, 2016

No Restricted Materials Above Threshold

EU REACH Regulation (EC) No. 1907/2006

Current ECHA Candidate List: JUNE 2022 (224)
Candidate List Declared Against: JUNE 2022 (224)
Does not contain REACH SVHC

Halogen Content

Not Low Halogen - contains Br or Cl > 900 ppm.

Solder Process Capability

Not applicable for solder process capability

Product Compliance Disclaimer

This information is provided based on reasonable inquiry of our suppliers and represents our current actual knowledge based on the information they provided. This information is subject to change. The part numbers that TE has identified as EU RoHS compliant have a maximum concentration of 0.1% by weight in homogenous materials for lead, hexavalent chromium, mercury, PBB, PBDE, DBP, BBP, DEHP, DIBP, and 0.01% for cadmium, or qualify for an exemption to these limits as defined in the Annexes of Directive 2011/65/EU (RoHS2). Finished electrical and electronic equipment products will be CE marked as required by Directive 2011/65/EU. Components may not be CE marked. Additionally, the part numbers that TE has identified as EU ELV compliant have a maximum concentration of 0.1% by weight in homogenous materials for lead, hexavalent chromium, and mercury, and 0.01% for cadmium, or qualify for an exemption to these limits as defined in the Annexes of Directive 2000/53/EC (ELV). Regarding the REACH Regulation, the information TE provides on SVHC in articles for this part number is based on the latest European Chemicals Agency (ECHA) 'Guidance on requirements for substances in articles' posted at this URL: <https://echa.europa.eu/guidance-documents/guidance-on-reach>

Compatible Parts

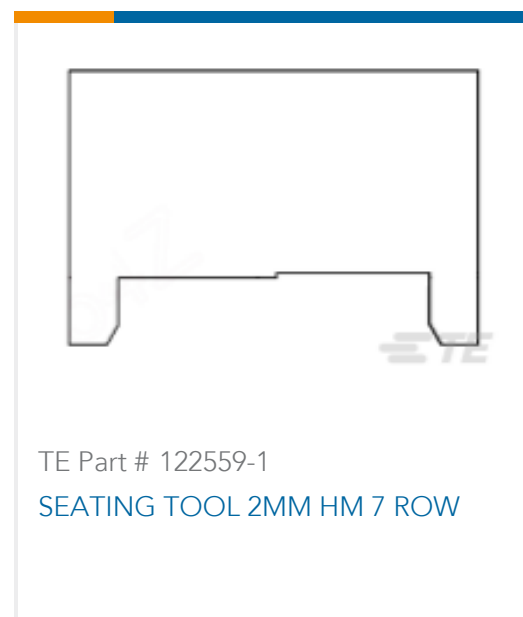

Also in the Series | **Z-PACK 2mm HM**

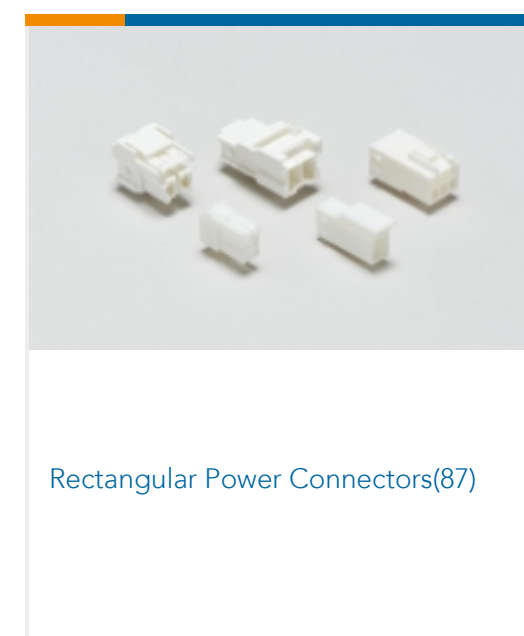
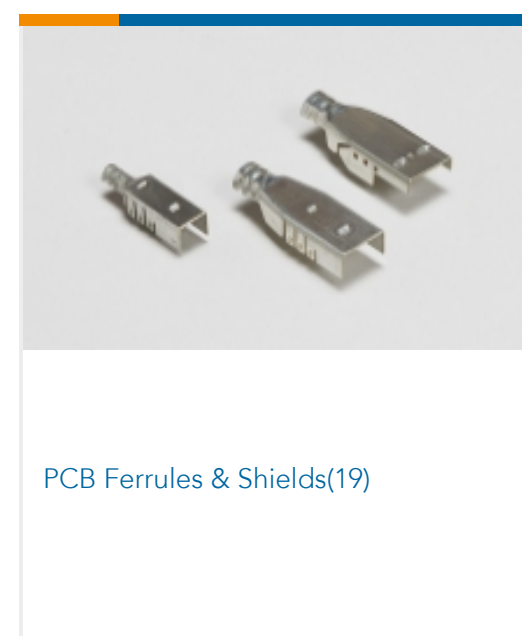
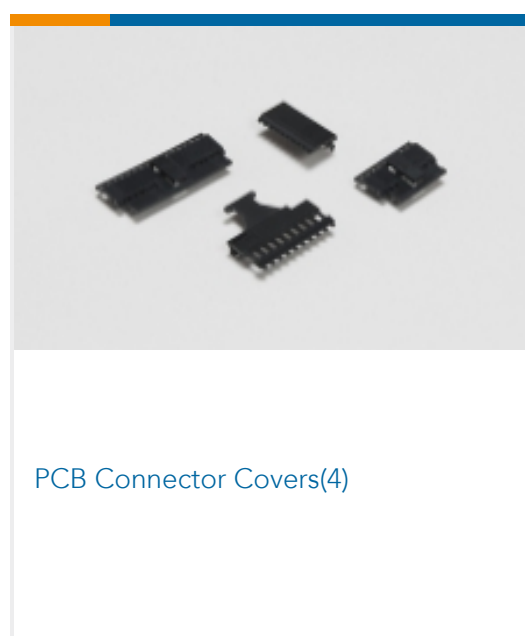
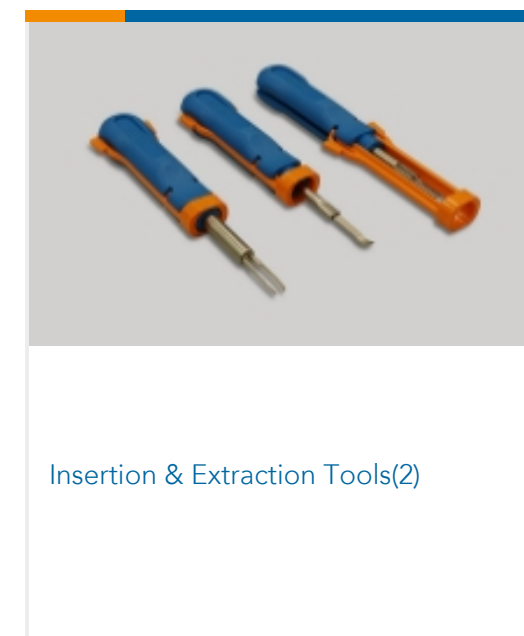
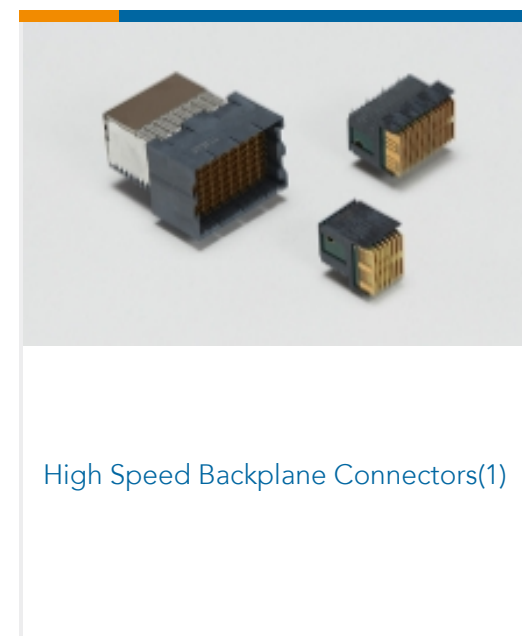
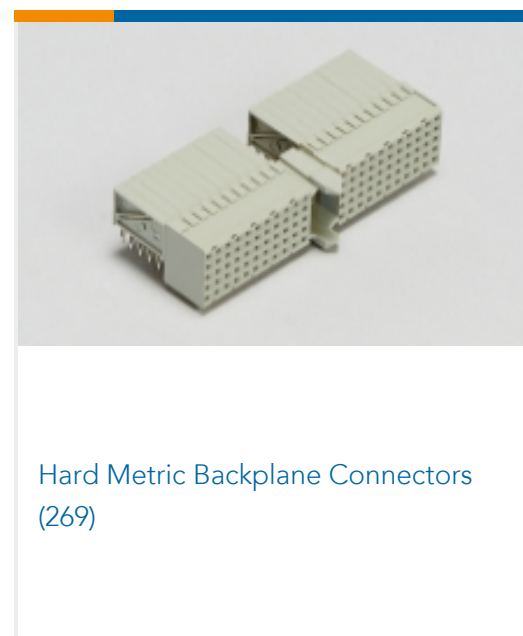
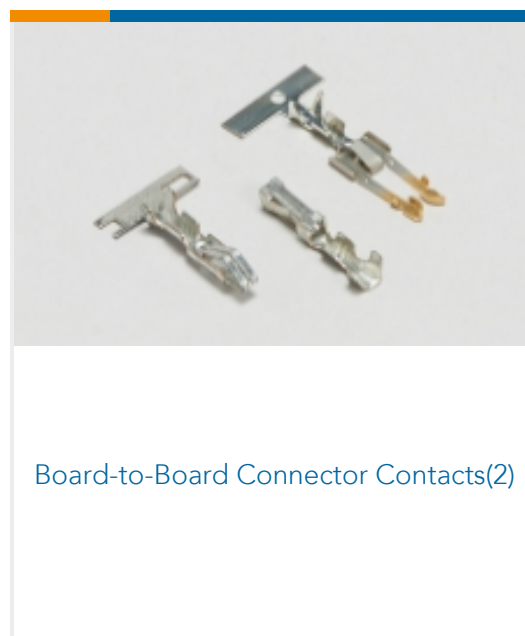
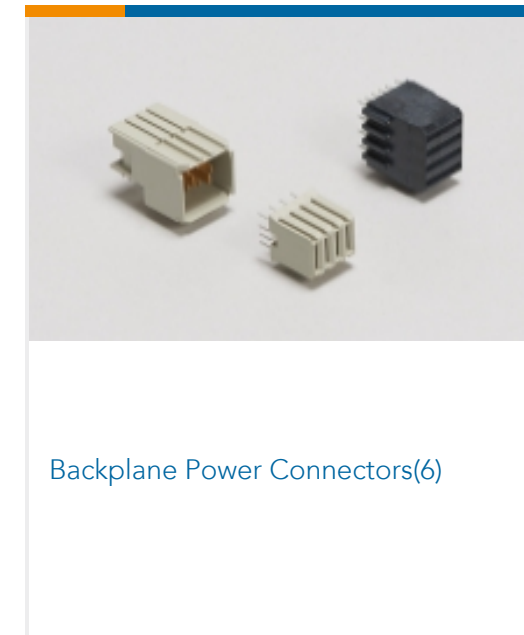
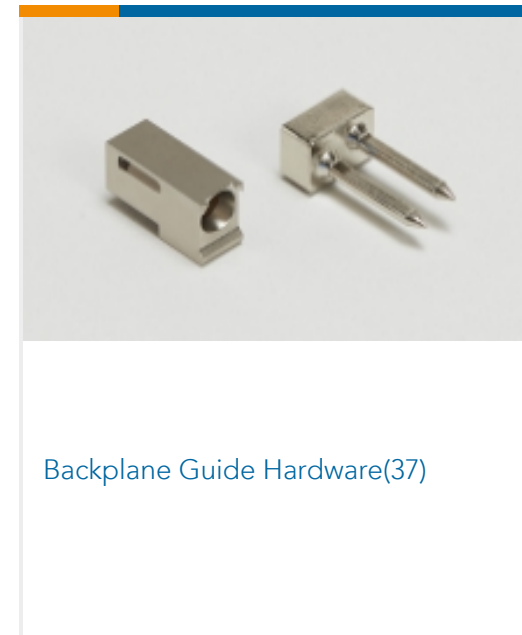
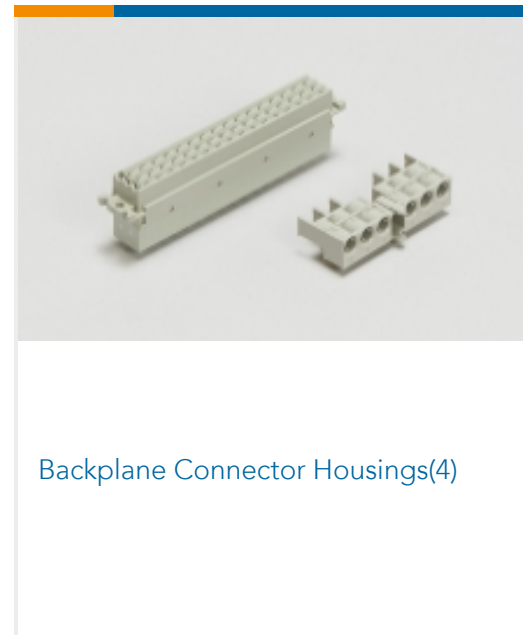
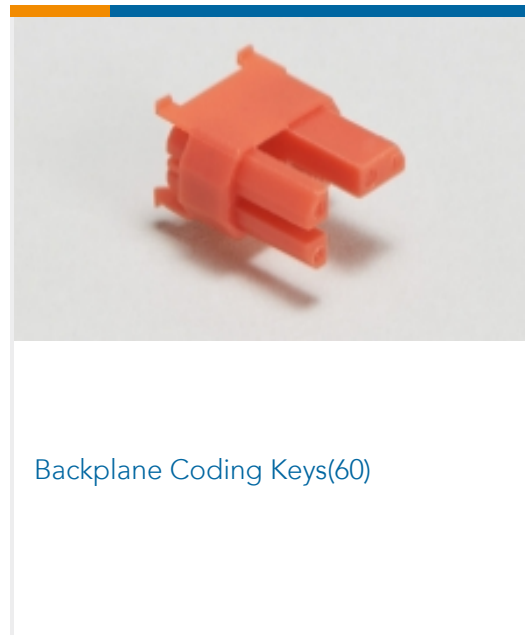

Documents

Product Drawings

Z-PACK 2mm HM/C RAF 55P

English

CAD Files

3D PDF

English

Customer View Model



[ENG_CVM_5100161-9_B.2d_dxf.zip](#)

English

Customer View Model

[ENG_CVM_5100161-9_B.3d_igs.zip](#)

English

Customer View Model

[ENG_CVM_5100161-9_B.3d_stp.zip](#)

English

By downloading the CAD file I accept and agree to the [Terms and Conditions](#) of use.

Product Specifications

[Application Specification](#)

English

[Application Specification](#)

English